

Operating instructions Hydraulic rescue equipment

SPREADER



SP 40 C, SP 44 AS, SP 49, SP 54 AS, SP 50 BS, SP 53 BS, SP 64 BS, SP 84 CS
8142696



Tested
according
to
EN 13204

www.weber-rescue.com

WEBER RESCUE
SYSTEMS

Table of contents

1 General information	4
1.1 About the operating manual	4
1.2 Explanation of symbols	5
1.3 Limitations of liability	6
1.4 Copyright	6
1.5 Warranty conditions	7
1.6 Customer service	7
2 Safety	8
2.1 Intended use	8
2.2 Responsibility of the customer	9
2.3 Operating personnel	10
2.4 Personal protective equipment	11
2.5 Specific hazards	12
2.6 Safety devices	14
2.7 How to respond in the event of danger or accidents	15
2.8 Signage	16
3 Technical data	17
3.1 Spreader	17
3.2 Operating conditions	18
3.3 Type plate	18
4 Structure and function	19
4.1 Overview	19
4.2 Brief description	19
4.3 Hydraulic supply	20
4.5 Use of the control handle	24
4.6 Changing the spreader tips	25
5 Possible applications	26
5.1 Safety information	26
5.2 Spreading	26
5.3 Pulling	27
5.4 Crushing	28
5.5 Lifting	29
5.6 Peeling	29

6	Transport, packaging and storage	30
6.1	Safety information	30
6.2	Transport inspection	30
6.3	Symbols on the packaging	31
6.4	Disposal of packaging	31
6.5	Storage	31
7	Installation and commissioning	32
7.1	Safety information	32
7.2	Checking	33
7.3	Installation	33
7.4	Shutting down (end of work)	34
8	Service	35
8.1	Safety information	35
8.2	Care and maintenance	35
8.3	Maintenance schedule	36
9	Malfunctions	37
10	Decommissioning / Recycling	38
11	EC Declaration of Conformity	39

1 General information

1.1 About the operating manual

This operating manual provides important information on using spreader devices. Proper compliance with all specified safety instructions and guidelines is a prerequisite for safe work.

Furthermore, adhere to the local accident prevention guidelines and general safety regulations for the region in which the devices are used.

These operating instructions must be carefully read prior to starting any work! They are an inherent part of the product and must be kept in a place that is known and accessible to personnel at all times.

This documentation contains information for operating your equipment. However, you may also find information which may not directly apply to your specific equipment.

All information, technical data, graphics and diagrams contained in these operating instructions are based on the latest data available at the time of the document's creation.

We recommend that, in addition to carefully reading through the operating manual, you be trained on handling the rescue equipment (possible applications, application tactics, etc.) by our qualified trainers.

1.2 Explanation of symbols

Warnings

Warnings are marked by symbols in this operating manual.

The individual instructions are introduced by signal words that express the severity of the hazard.

It is essential to comply with the instructions in order to prevent accidents, injuries and damage to property.



DANGER!

... indicates an imminently dangerous situation that can result in death or serious injury if not avoided.



WARNING!

... indicates a potentially dangerous situation that can result in death or serious injury if not avoided.



CAUTION!

... indicates a potentially dangerous situation that can result in minor or light injuries if not avoided.



ATTENTION!

... indicates a potentially dangerous situation that can result in material damage if not avoided.

Tips and recommendations



NOTE!

... highlights useful tips and recommendations, as well as information for efficient, trouble-free operation.

1.3 Limitations of liability

All information and instructions in this operating manual have been compiled in keeping with applicable standards and guidelines, the current state of technology, and our many years of knowledge and experience.

The manufacturer assumes no liability for damage due to:

- Failure to comply with the operating manual
- Unintended use
- Assignment of untrained personnel
- Unauthorised modifications
- Technical changes
- Use of non-approved replacement parts
- Use of non-original replacement parts

The actual scope of delivery can vary from the explanations and graphic representations provided in this manual in the case of special versions, or due to technical changes.

1.4 Copyright

All texts, diagrams, drawings and images in this operating manual may be used without restriction and without any prior approval.

**NOTE!**

Further information, images and drawings can be found on our website www.weber-rescue.com

1.5 Warranty conditions

The warranty conditions can be found as a separate document in the sales documentation.

1.6 Customer service

Our customer service is available to you for technical information.

Germany

DEG Service Center

Phone: +49 (0)7135 71 10112

E-mail: servicecenter@weber-rescue.com

Austria

ATL Service Center

Phone: +43 (0) 7255 6237-12473

E-mail: ATL.Servicecenter@weber-rescue.com

International:

For questions regarding spare parts, service and repair, please contact our certified local service partners. Scan this QR code for an overview of our worldwide service and sales network.

**NOTE!**

When contacting our customer service department please state your equipment's designation, type and production year. These details can be found on the equipment type plate.

2 Safety

This section of the operating manual provides a comprehensive overview of all the important safety aspects for optimal protection of operating personnel, as well as for safe and trouble-free operation.

Significant hazards can occur if the handling and safety instructions in this manual are not complied with.

2.1 Intended use

The hydraulic spreaders are designed and tested exclusively for the appropriate designated purposes described here. All other activities are fundamentally prohibited.

Spreaders (SP 40 C, SP 44 AS, SP 49, SP 54 AS, SP 50 BS, SP 53 BS, SP 64 BS, SP 80 CS)

- All of the spreaders are designed as one-man devices and may therefore be operated by one person only.
- The devices serve exclusively for the opening of doors, the lifting of vehicles or other moveable loads, the pushing away and moving of vehicle parts and loads and the crushing of tubes and pillars.
- The spreader tips should be used whenever possible for crushing.
- The spreader tips can be used as a peeling tool.
- The chain set is to be used exclusively for pulling.



WARNING!
Improper use can be dangerous!

Any improper or unintended use of the devices can be hazardous!

Therefore, make absolutely sure that:

- » The devices are used only for the applications stated above.
- » All other information on proper use of the devices in Chapter 5 (Possible applications) is observed.

2.2 Responsibility of the customer

In addition to the health and safety instructions in this operating manual, one must adhere to the safety, accident prevention, and environmental protection guidelines for the region in which the equipment is used. Particularly applicable in this regard:

- The customer must be familiar with the applicable health and safety provisions and in a hazard analysis identify other hazards that may exist at the equipment's installation site due to the special working conditions.
- The customer must clearly regulate and specify responsibilities for installation, operation, maintenance and cleaning.
- The customer must ensure that all personnel who handle the equipment have fully read and understood the operating manual.
- In addition, at regular intervals, the operator must train personnel and inform them of the hazards of working with the equipment.

Moreover, the customer is responsible for ensuring that the equipment is always in technically faultless condition. Consequently, the following applies:

- After each use, and at least once a year, a visual inspection of the equipment must be carried out by a trained individual (according to DGUV Grundsatz 305-002 or country-specific guidelines).
- Every three years, or if you have doubts about the safety or reliability of the equipment, functional testing and stress testing must be carried out (according to DGUV Grundsatz 305-002 or country-specific guidelines).

2.3 Operating personnel

The following qualifications are cited in the operating instructions for the various activity areas:

- **Trained individual**
is informed through training offered by the customer about the tasks assigned to him and the possible dangers of improper conduct.
- **Specialist**
is someone who, due to specialised training, skills and experience, as well as knowledge of the applicable stipulations by the manufacturer, is capable of executing the tasks assigned to him or her and of independently recognising possible hazards.



WARNING!

Inadequate training can result in injuries!

Improper handling of the equipment can lead to serious injury or material damage.

Therefore, make absolutely sure to:

- » allow particular tasks to be carried out only by the persons stated in the relevant chapter of this manual.
- » When in doubt, call in specialists immediately.



NOTE!

The equipment may not be used by personnel who have consumed alcohol, medication or drugs!

2.4 Personal protective equipment

Wearing personal protective equipment (PPE) is essential to minimise the risks to operating personnel when working with the hydraulic rescue devices.

It is essential to wear the following protective clothing for all work:



Protective work clothing

Tight-fitting work clothing with tight sleeves and no protruding parts must be worn when working. It mostly serves to protect against entanglement by moving equipment parts.



Safety shoes

Steel-toed safety shoes must always be worn as protection against heavy falling parts and from slipping on slick surfaces.



Work gloves

Work gloves must be worn when working with the equipment to provide protection from sharp edges and shards of glass.



Helmet with face shield

A helmet with face shield must be worn for protection against flying or falling parts and shards of glass.



Protective goggles

Protective goggles must also be worn in addition to the face shield in order to protect the eyes from flying objects.

The following must also be worn for certain work:



Ear protectors

In addition to the basic protective equipment, ear protectors must also be worn to protect your hearing.

2.5 Specific hazards

The hazards arising from the risk analysis are listed in the following section.

Follow the safety instructions listed here and the warnings in the other sections of this manual to minimise potential health hazards and avoid dangerous situations.

Electricity



DANGER!

Danger of fatal electric shock!

There is an imminent life-threatening danger if live parts are touched. Damage to insulation or to specific components can pose a fatal hazard.

Therefore:

- » If the insulation is damaged, immediately disconnect the power supply and arrange for repairs.
- » Allow only qualified electricians to work on the electrical equipment.
- » For all work on the electrical equipment, it must be disconnected from the power source, and it must be checked that the device is de-energised.
- » Prior to maintenance, cleaning and repair work, the power supply must be switched off and secured to prevent it from being switched back on again.
- » Do not bypass or disable fuses.
When changing the fuses, ensure that they have the correct amperage.
- » Keep moisture away from live parts.
This can lead to a short-circuit.

Noise



WARNING!
Noise can damage hearing!

The noise occurring in the work area can cause severe hearing damage.

Therefore:

- » You should also wear ear protectors when carrying out certain noise-producing tasks.
- » Do not stay in the hazardous area longer than necessary.

Hydraulic power



WARNING!
Hydraulic power hazard!

Serious injury can result due to the released hydraulic forces and escaping hydraulic oil.

Therefore:

- » Constantly monitor the device during the work procedure and set down if necessary.
- » Inspect the hose lines and devices for damage after every use.
- » Avoid skin contact with the hydraulic oil (wear protective gloves).
- » Immediately remove the hydraulic oil from wounds and consult a doctor.

2.6 Safety devices

Safety valve for SKS couplings

If the return line is not correctly coupled such that the oil cannot return then a safety valve integrated into the control handle actuates in order to protect the equipment and the operator. This causes hydraulic oil to seep harmlessly from the end of the handle.

Move the switching valve on the hydraulic power unit immediately to the „0“ position and connect the coupling parts together correctly.

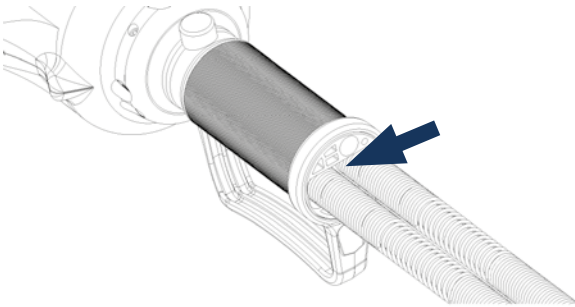

WARNING!

Danger due to incompletely coupled SKS return line!

If the return line (T) is not correctly connected with the SKS coupling system the device can move independently until the safety valve responds!

Therefore:

- » Always check SKS couplings for correct locking.
- » Make sure that hands and other parts of the body are not within the working range of the moving parts.

2.7 How to respond in the event of danger or accidents

Preventive measures

- Always be prepared for accidents
- Keep first aid equipment (first aid kit, blankets, etc.) at hand
- Familiarise personnel with accident alarms, first aid gear, and emergency equipment
- Keep entryways clear for emergency vehicles

In the event of an accident

- Shut down equipment immediately
- Initiate first aid measures
- Get people out of the danger zone
- Inform the responsible parties at the site of the incident
- Notify a doctor and/or the fire brigade
- Clear entryways for emergency vehicles

2.8 Signage

The equipment bears the following symbols and instructional signs. They refer to the immediate vicinity in which they are affixed.



Comply with the operating manual

Do not use the marked equipment until you have read the operating manual.



Hand injury warning

When working with the equipment, take care to avoid hand injuries through trapping or sharp edges.



WARNING!

Danger of injury due to illegible symbols!

Over time, stickers and symbols on the equipment can become soiled or otherwise illegible.

Therefore, make absolutely sure to:

- » keep all safety, warning and operating information on the device easily legible.
- » replace damaged signs and stickers immediately.

3 Technical data

3.1 Spreader



SP 40 C



SP 44 AS



SP 49



SP 53 BS



SP 54 AS



SP 50 BS



SP 64 BS



SP 84 CS

	SP 40 C	SP 44 AS	SP 49	SP 53 BS
Dimensions (LxWxH)	708 x 269 x 188 mm	708 x 250 x 190 mm	791 x 248 x 199 mm	836 x 299 x 216 mm
Weight	9,8 kg	13,3 kg	19,9 kg	20,3 kg
Spreading distance	515 mm	610 mm	710 mm	800 mm
Pulling distance	370 mm	460 mm	561 mm	645 mm
Spreading force in working range *	40 – 173 kN	44 – 857 kN	49 – 330 kN	53 - 421 kN
Pulling force	46 – 70 kN	45 – 74 kN	38 – 48 kN	39 - 66 kN
Max. squeezing force *	56 kN	149 kN	101 kN	100 kN
Nominal pressure	700 bar	700 bar	700 bar	700 bar
EN class (EN 13204)	-	AS 44/610-13,3	AS 49/710-19,9	BS 53/800-20,3
ID No.	1087650	1082518	5933633	1058125

	SP 54 AS	SP 50 BS	SP 64 BS	SP 84 CS
Dimensions (LxWxH)	821 x 282 x 200 mm	854 x 282 x 200 mm	879 x 307 x 210 mm	790 x 307 x 210 mm
Weight	16,9 kg	17,1 kg	20,1 kg	19,8 kg
Spreading distance	735 mm	805 mm	820 mm	660 mm
Pulling distance	620 mm	680 mm	702 mm	540 mm
Spreading force in working range *	55 - 501 kN	50 - 501 kN	64 - 680 mm	82 - 680 mm
Max. pulling force	70 kN	67 kN	74 kN	93kN
Max. squeezing force *	144 kN	144 kN	129 kN	129 kN
Nominal pressure	700 bar	700 bar	700 bar	700 bar
EN class (EN 13204)	AS55/735-16,9	BS50/805-17,1	BS64/820-20,1	CS82/660-19,8
ID No.	1089800	1090581	1093902	1093904

* per EN 13204

3.2 Operating conditions

The permissible operating temperature range for the spreader lies between -20° C and +55° C. Reliable operation cannot be guaranteed outside of this range.

Underwater operation

The spreader can also be used under water. Do not exceed the maximum submersion depth of 40 metres with this. At this depth the water pressure still has no influence on the hydraulic pressure in the equipment and the hoses.



NOTE !

After underwater use in saltwater, the equipment must be completely disassembled and cleaned. With fresh water complete cleaning is sufficient.

After operation in moisture or underwater, the unit must be dried in any case. Burnished parts (bolts, blades and lugs) must be greased or lubricated.

3.3 Type plate

On all spreder devices, the type plate is located on the body. It shows the serial number, production date, nominal pressure and device designation.

4 Structure and function

4.1 Overview

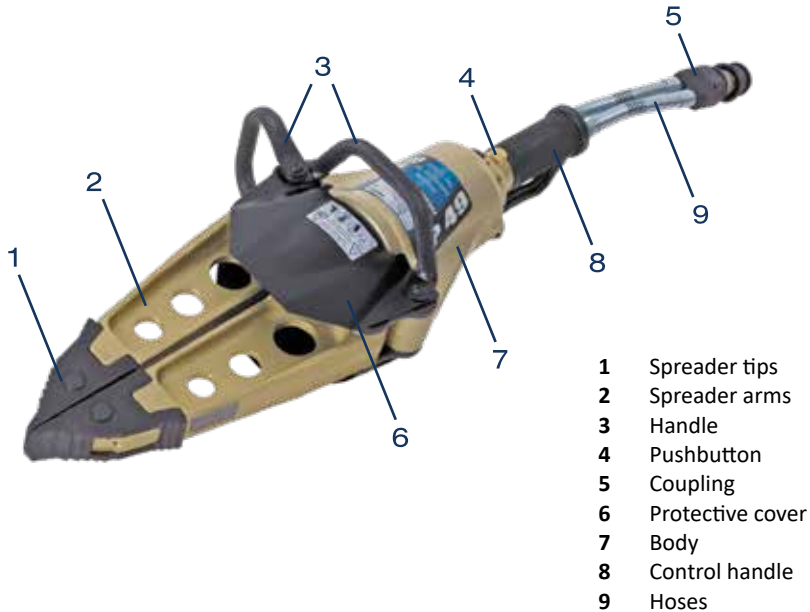

4.2 Brief description

Hydraulic spreaders are specially designed rescue equipment for spreading, squeezing and pulling. They are used for rescuing trapped or enclosed accident victims.

Driven by a hydraulic power unit it is possible to open doors, lift vehicles and other moveable loads, push away and move vehicle parts and loads and crush tubes and pillars with the spreaders.

The speed of movement of the spreader arms is controlled by the greater or lesser degree of force applied to the pushbutton on the handle. The maximum spreading force is only applied when the pushbutton is fully depressed.

4.3 Hydraulic supply

Power units and pumps

Only WEBER-HYDRAULIK power units and hand pumps may be used to drive the spreader. Equipment from other manufacturers can only be used under certain conditions. Therefore always consult with us before operating a device with a power unit from another manufacturer!



ATTENTION!

Before using pumps and power units from other manufacturers always contact WEBER-HYDRAULIK or an authorised dealer.

Incorrect application can lead to hazardous situations for which we cannot accept any liability!

Hoses

The connection of the device with the power unit is carried out via high pressure hoses. Hoses are available in lengths of 5 m, 10 m, 15 m and 20 m. As the length of the lines increases so too does the associated pressure loss. With a line length of 50 metres this pressure loss remains acceptable and has no significant effect.



CAUTION!

Do not use damaged hoses!

With damaged hoses there is a danger of escaping hydraulic medium under pressure, or of the hoses whipping around.

Therefore:

- » The hoses should be subjected to a visual inspection (leak-tightness, surface damage such as kinks) after every use and at least once per year

- » Every three years, or in the event of doubts about the safety or reliability, carry out an additional functional and load test (as per DGUV Grundsatz 305-002 or specific national directive).
- » Replace hoses every 10 years! The date (code letters or quarter/year) is specified on the hose bonding.
- » Ensure that the hoses are not exposed to tension or torsion (turning).
- » Do not kink the hoses or draw them over edges (smallest bend radius 40 mm).
- » Do not subject the hoses to high temperatures.
- » Protect hoses from contact with materials that can cause damage to the outer covering e.g. acids, alkalis, or solvents.

Hydraulic oil

All spreaders are designed and tested for WEBER hydraulic oil Part no. 804932. This oil possesses a particularly high purity level and also works flawlessly at temperatures below zero, down to -20° C.

With limitations in the low temperature range (low output), however, a standard oil (mineral based) of viscosity class HLP 10 or HVLP 10 can be used in keeping with DIN 51502.



NOTE !

We recommend the following hydraulic oils for trouble-free operation of WEBER rescue devices:

- » AERO Fluid 41 (Shell)
- » Univis HVI-13 (Esso)
- » Aero-hydraulic 520 (Total)
- » Hydraulik DB (Castrol)
- » Renolin/MR310 (Fuchs)
- » HVI Extra 380 (Maier & Korduletsch)
- » Hydrex Arctic 15 (Petro Canada)
- » Naturelle HFE 15 (Shell)

4.4 Equipment connections

SINGLE coupling

Connecting:

Remove the protective cap from the coupling male and the coupling female (Fig. 1).

Conflate Single coupling male and female in the bayonet catch (Fig. 2). Hold coupling female on the black slew ring and turn clockwise until the coupling snaps in (Fig. 3). Put protective caps together (Fig. 4). You don't have to switch the power unit to position 0 to connect or disconnect the coupling!

Disconnecting:

Remove the protective caps. Hold coupling female on the black slew ring and turn anticlockwise direction. Turn the black slew ring until you can release the coupling easily. Put protective caps to coupling male and the coupling female.

Fig. 1



Fig. 2



Fig. 3



Fig. 4



NOTE !

When using the SINGLE coupling, pressure relief connectors are no longer required.

Plug-in coupling (SKS)

Connecting:

Remove the protective cap from the coupling male. Take hold of the coupling female by the knurled sleeve cover and pull out the protective plug. With one hand take hold of sleeve cover of the coupling female, with the other grasp the coupling male (black) by the hex nut, and press the sleeve cover slightly against the coupling male until the ball bearings engage. Twisting the male coupling slightly when pressing together eases the coupling process.

Disconnecting:

Grasp the coupling male (black) by the hex nut with one hand and with the other take hold of the sleeve cover and draw it back. The disconnecting will cause a few drops of hydraulic oil to escape. Plug in the protective caps immediately.

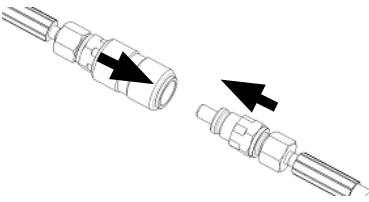

CAUTION!

When coupling SKS connections the power unit operating lever must be in the „0“ position. Make sure that the couplings, especially the return line (T), are correctly locked!



NOTE !

A pressure relief connector is fitted to the hydraulic power units and the hand pump, with which a few drops of oil can be discharged from the hoses. This permits re-coupling following pressure increases in de-coupled equipment.

In this case simply insert the pressure relief connector into the coupling sleeve and turn the knurled screw to the right until oil leaks out.

**NOTE !**

The following section only pertains to the SINGLE coupling. When connecting SKS couplings first ensure that the control lever is in the „0“ position!

4.5 Use of the control handle

The spreader can be operated by the pushbutton on the control handle. The speed of movement of the spreading arms is controlled precisely by the greater or lesser degree of force applied to the pushbutton.

The maximum spreading force is only applied when the pushbutton is fully depressed.

Opening the spreader

The primary motion direction of the device (opening) is triggered by pressing the lower tapered (convex) end of the button.

The direction of movement is marked on the equipment with the symbol:



Closing the spreader

The spreader is closed with the upper curved (concave) end of the button, which is marked with the following symbol:



Dead-man's switching

If the pushbutton is released then it returns to the neutral position automatically. With this, the device stops still in any position (including under load).

4.6 Changing the spreader tips

The spreader tips are secured in the spreader arms with collar studs. In order to change, press out the studs secured by a spring-loaded ball. After changing the tips, push the collar studs back in again. When doing this ensure that the studs are correctly fitted (completely pressed in).

Fitting the bracket for the chain set is identical. The chain lock must be fitted with the lock facing upwards.

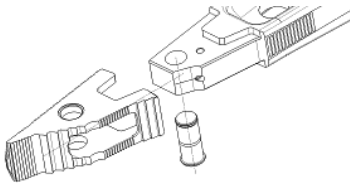

The collar studs on the spreader tips can be pressed out of the spreader arms but have a safety system to prevent them being lost and so they cannot be separated from the tips.

The SP 40 C and SP 44 AS spreader tips are not secured with removable collar studs but rather with a tensioning pin that must be knocked out when the tips are being changed. The chain set can be fastened in a separate hole without having to remove the tips beforehand.

5 Possible applications

5.1 Safety information

**WARNING!**

Never reach between the spreader arms!

**WARNING!**

During all work with the spreaders, parts which are tensioned can break off or be blown off and thus endanger personnel.

Therefore, personnel who are not directly involved must maintain a safe distance or only stay in the hazardous area as long as is strictly necessary.

5.2 Spreading

With the help of the spreader function, it is possible to open doors, lift vehicles and other moveable loads, push away vehicle parts and crush tubes and pillars, amongst other things. A stable positioning and support of the vehicle is essential with this.

In order to avoid slipping off when spreading, the arms and tips are serrated on the inner and outer sides.

It is best to spread using this area because the spreading force is highest here. In addition, slipping of can be avoided by readjusting the spreaders. If possible the tips should only be used to enlarge a gap.

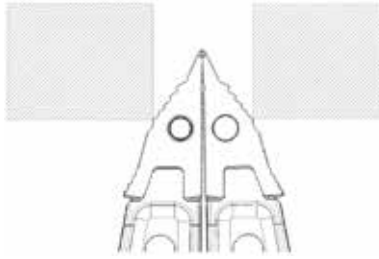
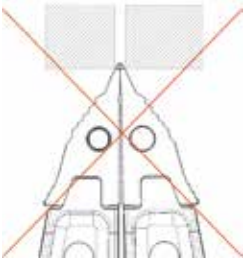

5.3 Pulling

After the chain set (as explained in chapter 4.6) has been mounted on the spreader tips, the spreader device can be used for pulling.

For this, the chains must be tightly tensioned and must be tensioned only in the pulling direction. To tension the chain, only one lock can be pressed in, so that the chain can be pulled through the holder.

If the range of movement is not sufficient, tension chains or other means must be used so that the spreader can be reopened and the chain retensioned.



ATTENTION!

Store the pulling chains with locks mounted about 10–20 cm from the end. Check the chains prior to every use. Check that the weight does not stress the tip of the hook, but lies in the middle of the hook instead.

- » Do not make any repairs on your own.
- » Do not stress the chains beyond the permitted load carrying capacity.
- » Do not load with a jerking movement.
- » Do not galvanize or paint the chains.
- » Do not shorten the chain by knotting it.
- » Do not subject the chains to heat stress.
- » Use the chains and accessories only between -40°C and $+200^{\circ}\text{C}$.
- » During all maintenance work, observe the applicable German accident prevention regulations (UVV) as well as the specifications of DIN EN 818-7 and DIN 685-5.
- » Chains must only be used for lashing. Lifting loads is not permitted.



Chains must not be used if:

- » Deformations, cracks, signs of corrosion are present.
- » The wire diameter of the chain link has decreased by 10% of the nominal thickness.
- » An individual chain link has been permanently stretched.
- » An individual link has been enlarged by more than 2%.
- » The internal chain pitch over a measuring distance of 11 chain links has increased by more than 2%.

5.4 Crushing

Pipes and other hollow profiles are crushed by closing the spreader arms. If possible obly use the tips to crush material. With the old SP 35 with steel arms it's also possible to use the fluted area of the arms.

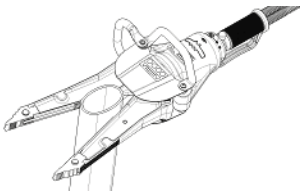

ATTENTION!

Material to be crushed can suddenly jump away.
Do not remain in the work area of the spreading devices!

5.5 Lifting

The spreader can also be used for lifting vehicles or other movable loads.

Care must be taken to secure the load against slipping away and to position the spreader tips far enough apart under the load to prevent slipping.

The load being lifted must be constantly monitored (tipping, rolling away or changing position). Also, the lifted load must immediately be propped up and supported in a suitable way.

5.6 Peeling

In order to create entry points in bus accidents, train accidents, silos etc. it is possible to use the spreader tips as a peeling tool.

6 Transport, packaging and storage

6.1 Safety information

**CAUTION!****Incorrect transport can cause damage!**

Improper transport can cause significant material damage.

Therefore:

- » Proceed with caution when unloading the packages, and observe the symbols on the packaging.
- » Do not fully open and remove the package until it has reached its actual storage location.

6.2 Transport inspection

Upon receipt, the delivery should be checked immediately for completeness and damage during transport so that a quick remedy can be performed, if necessary.

If there is visible external damage, please proceed as follows:

- Do not accept the delivery, or only accept it with reservation.
- Note the extent of the transport damage on the transport documents or on the transport company's delivery note.
- File a complaint.

**NOTE!**

Report any defect as soon as it is detected.

Claims for damages can be directed to our customer service department (see Chapter 1.6).

6.3 Symbols on the packaging

**Caution fragile!**

Handle the package carefully - do not drop, throw, strike or tie up.

**This way up!**

The package must be transported and stored strictly so that the arrows point upward. Do not roll or tilt.

6.4 Disposal of packaging



All packaging materials and disassembled parts (transportation protection) must be disposed of properly, in accordance with applicable local regulations.

6.5 Storage

The equipment must be stored in a dry and dust-free environment, where possible. Avoid direct UV radiation to the hoses.

**CAUTION!**

The equipment must be stowed securely in the mountings provided in order to avoid damage during transit, etc.

7 Installation and commissioning

7.1 Safety information

**WARNING!****Danger of injury due to improper operation!**

Improper operation can cause serious injury or material damage.

Therefore, make absolutely sure to:

- » All operating steps are executed in keeping with the information in this operating manual.
- » All covers and protective devices are installed and in proper working order prior to starting work.

Personal protective equipment

Wear the protective equipment detailed in Chapter 2.4 for all work!

**NOTE!**

Special reference is made where it is necessary to wear additional protective equipment for certain work with or on the device.

7.2 Checking

Check the spreader for damage. If the equipment should be found not to be in flawless condition then it must not be used! In this event, inform your supplier immediately.

- Check the spreader arms and tips (damage)
- Check the control handle including pushbutton (function)
- Check the couplings (damage, dirt)
- Check the hand grip (securely fastened)
- Check the protective cover (damage)
- Check the hoses (damage)

7.3 Installation

Move both control levers on the hydraulic power unit to the „0“ position (Fig. 1), pull off the dust protection cover of the coupling and connect the hydraulic hoses with the spreader as described in chapter 4.4. In order to avoid contamination then connect the protective caps. When using the SINGLE coupling, coupling can also be carried out without pressure („0“ position on power unit not necessary).

When operating a hydraulic power unit observe the operating instructions for the equipment!

Fig. 1

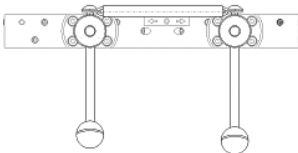

7.4 Shutting down (end of work)

Once the work is complete the spreader arms must be driven together in order to relieve the hydraulic load on the spreader.

The arms must never be fully closed as this will cause hydraulic stress to be built up in the equipment.

Then the equipment can be disconnected providing that the power unit control lever is in the „0“ position. Care must be taken to ensure that no dirt ends up on the coupling and that the protective caps are immediately fitted.

8 Service

8.1 Safety information



WARNING!

Risk of injury due to improperly performed maintenance work!

Improper maintenance of the equipment can cause serious injury or material damage.

Therefore, make absolutely sure to:

- » Only let qualified personnel carry out maintenance work.
- » Make sure the installation site is organised and clean! Loose components and tools lying around are sources of danger.
- » Wear protective gloves for all work!

8.2 Care and maintenance

In the interest of permanent operational readiness, the following measures are essential:

- Each time the device is subjected to a load, but at least once a year, the equipment and the accessories must be visually inspected. Special attention must be paid to spreader tips, joints, blades, hoses, and coupling halves.
- Every three years, or if there are doubts about the safety or reliability of the equipment, functional testing and stress testing must also be carried out (according to DGUV Grundsatz 305-002 or country-specific guidelines).
- After every loading, the lubrication of the movable parts and pins must be inspected and sprayed with a suitable grease.
- Every three years, the complete hydraulic oil of the spreader must be replaced.

**ATTENTION!**

Prior to all maintenance work, the equipment must be cleaned of any dirt so that it does not get into the hydraulic system.

The cleaning can be carried out using a conventional citrus cleaner.

8.3 Maintenance schedule

A precise maintenance plan with testing intervals, regulations and results can be found in the DGUV Grundsatz 305-002 Point 18 (hydraulically operated rescue equipment).

**NOTE!**

If there are any problems with the maintenance of the devices, our customer service is available (see Chapter 1.6).

9 Malfunctions

Fault	Possible cause	Remedial measures
Equipment fails to deliver full performance	Control buttons not fully depressed	Fully depress control buttons
Equipment delivers no power or moves in the opposite direction to that commanded	Pressure line (P) and return line (T) were transposed when hoses or couplings were replaced	Change round, repair by authorised customer service
Spreader cannot be coupled	Pressure build-up due to heating (only SKS coupling) Coupling is damaged or heavily soiled	Drain a little oil out of the equipment with the pressure relief plug, see chapter 4.3 (only SKS coupling)
Oil escaping at the control handle (hole between the hoses)	Return hose is not correctly coupled (only SKS coupling)	Move power unit control lever to the "0" position and couple correctly (only SKS coupling)
Equipment non-functional despite actuating the control buttons	Pressure hose is not coupled	Move power unit control lever to the "0" position and couple correctly (only SKS coupling)
Spreader exhibits movement in the opposite direction under load	Check non-return valve	Have the equipment checked by authorised customer services
Oil discharge on the hoses or their bondings	Hoses leaking, possibly due to damage	Repair by authorised customer service
Degradation of the surfaces of the hoses	Contact with aggressive chemical fluids	Repair by authorised customer service
Oil escaping at the coupling halves	Coupling leaking	Replace coupling, repair by authorised customer service

10 Decommissioning / Recycling

After the end of the normal service life, the equipment must be professionally disposed of. Individual parts can, however, certainly be used again.

The hydraulic oil must be completely drained and collected. Make sure that the hydraulic oil is disposed of separately!

For disposal of all device components and packaging materials, the disposal conditions of the specific location apply.



NOTE!

Please ask your supplier about disposing of the device.

11 EC Declaration of Conformity

WEBER-HYDRAULIK GMBH

Emil Weber Platz 1, A-4460 Losenstein, Austria

EC-DECLARATION OF CONFORMITY

according to Directive 2006/42/EC

Herewith we declare, that our "Hydraulic rescue Equipment"

SPREADERS	SP 35 AS, SP 40 EN, SP 40 C, SP 44 AS, SP 49, SP 50 BS, SP 54 AS, SP 53 BS, SP 60, SP 64 BS, SP 80, SP 84 BS
CUTTERS/COMB-TOOLS	S 25-20, S 33-14, S 50 (-14), S 140-26 (LIGHT), S 220-54, S 270-71, C 100-31, RS 130-49, RS 170-105, RSU 180 PLUS, RSU 210 PLUS, RSK 105-29, RSK 160 (-50), RSK 165-65, RSK 180-80 (PLUS), RSK 185 (-105), RSK 200-107 (PLUS), SPS 270 (LIGHT), SPS 270 (MK2), SPS 360 (L) (MK2), SPS 370 (MK2), SPS 400 (MK2)
RAMS	RZ 1-755, RZ 1-800, RZ 1-850, RZ 1-955 L, RZ 1-465 LIGHT, RZ 1-580 LIGHT, RZ 1-1810 CROSSHAMMER, RZ 2-1290, RZ 2-1415 L, RZ 3-1640, RZD 2-1200, RZT 2-600 (RC7), RZT 2-775, RZT 2-1170, RZT 2-1500, RZT 2-610 XL, RZT 2-1120 XL, RZT 2-1250 XL, RZT 2-1275 XL, RZT 2-1500 XL, RZT 3-1310 XL
SPECIAL TOOLS	BC 250, C 45-B, SPK 250, DO 105, DO 120, HANDMARIO RIT TOOL, SBH 15-255, MSE 15-255, SPS 270 H, RSK 145-29 H,
POWER-UNITS	E/V 50L..., E/V 70L..., E/V 400 (S)..., V 400 ECO, B-COMPACT (ECO/ECO XL), E-COMPACT, V 50 ECO, V-ECOCOMPACT, V-ECOSILENT, AKKUPAC (ECO)
HANDPUMPS/ACCESSORIES	DPH 0705..., DPH 3215..., DPH 4018..., DPF 4018, EPH 0203 and accessories to all tools

meets the relevant basic safety and health requirements of the Directive

EC-MACHINE DIRECTIVE 2006/42/EC

EC-DIRECTIVE RoHS 2011/65/EU

For the relevant implementation of the safety and health requirements mentioned in the directives, the following standards and or technical specifications has been respectest

EN 13204 : 2016

EN ISO 13857 : 2019

NFPA 1936 : 2020

EN ISO 12108 : 2010

The tools are tested according to EN 13204:2016 and NFPA 1936:2020 through TÜV-Süd.

Authorised person to compile the technical file(s): Josef Eder - Head of Development

WEBER-HYDRAULIK GMBH
 A-4460 Losenstein - Emil Weber Platz 1

WEBER-HYDRAULIK GMBH

Heilbronner Straße 30
74363 Güglingen, Germany
Phone +49 7135 71-10270
Fax +49 7135 71-10396

Emil Weber Platz 1
4460 Losenstein, Austria
Phone +43 7255 6237-120
Fax +43 7255 6237-12461

www.weber-rescue.com